

Altena

Evoluindo com a luz

Trilhos e projetores
Tracks and projectors
Rieles y proyectores



2010

Altena

Evoluindo com a luz

**Não só evoluimos com a luz,
mas contribuimos com sua evolução.
São mais de trinta e cinco anos de história
sem nunca desviarmos da luz.
Podemos dizer que temos paixão por ela.
Continuamos amando o que fazemos!**

**We not only improve with the light,
but we contribute to its evolution.
Over thirty five years of history and
never turned away from the light.
We can say that we have passion for it.
We still love what we do!**

Non sólo progresamos con la luz,
pero contribuimos a su evolución.
Más de treinta y cinco años de historia
y nunca nos apartamos de la luz.
Podemos decir que tenemos pasión por ella.
¡Todavía amamos lo que hacemos!



disposições gerais

general information

informaciones generales

Todos os produtos são fornecidos sem lâmpadas e sem equipamentos, a não ser quando devidamente especificados.

All products are provided without lamps and equipment, except when specified.

Todos los productos son concedidos sin lámparas y equipos, excepto cuando se indique lo contrario.

acabamentos

finishes

acabado

Metal / Metal / Metal

-  **branco fosco**
matte white
blanco mate
-  **branco brilho**
bright white
blanco brilho
-  **chromo**
chromo
cromo
-  **escovado**
brushed
aluminio cepillado

-  **preto fosco**
matte black
negro mate
-  **preto brilho**
brightnes black
negro brilho
-  **cinza prata**
silver gray
gris plateado
-  **cinza titânio**
titanium gray
gris titanio

Filtros / Filters / Filtros

-  **âmbar**
amber
ámbar
-  **amarelo**
yellow
amarillo
-  **azul**
blue
azul
-  **ultra violeta**
UV
UV

-  **verde**
green
verde
-  **vermelho**
red
rojo
-  **satinado**
satin
satinado
-  **transparente**
translucent
transparente

simbologia geral

general symbology





















simbología general

-  **tipo de lâmpada**
kind of lamp
tipo de lâmpada
-  **curva fotométrica**
photometric curve
curva fotométrica
-  **nicho quadrado**
squared niche
nicho cuadrado
-  **diâmetro do furo**
hole diameter
diámetro del agujero
-  **rotação horizontal**
horizontal rotation
rotación horizontal
-  **grau de extraibilidade**
exorability degree
grado de salida

lâmpadas

lamps

lámpadas

- | | | | |
|--|--|--|--|
|  TC-TSE
Eletrônica E27 |  TC-D
Compacta Dupla |  TC-TEL
Compacta Tripla |  TC-TSE
Twister |
|  QT14
Halopin |  HIT-DE/QT-DE12
HQI-TS |  HIT-CRI
CDM-T |  HI-R111
CDM-R 111 |
|  R63
Mini-Spot |  QR-CB51 / QR-CB35
Dicróica 12V |  QPAR16
GZ-10 |  QR111
AR-111 |
|  QR70
AR70 |  QPAR38
PAR38 |  QPAR30
PAR30 |  QPAR20
PAR20 |
|  QR48
AR48 |  HI-PAR38
CDM-R PAR38 |  HI-PAR30
CDM-R PAR30 |  HI-PAR20
CDM-R PAR20 |

tipo de fixação

kind of fixation

tipo de fijación

LED

- C** com canopla de metal
with metal canopy
con base de metal
- CC** com cone anti-ofuscante
with glare control cone
con cono anti-deslumbramiento
- CG** caixa para equip. convencional
regular equip box
caja para equipo convencional
- CP** com canopla plástica
with plastic canopy
con base plástica

- PL** com adaptador Altrac
with Altrac adaptor
con adaptador Altrac
- R** com base para equip. remoto
with remote equip basis
con base para equipo remoto
- UN** com adaptador Minitondo
with Minitondo adaptor
con adaptador Minitondo

-  **LED PAR**
SUPERLED
POWERLED
E27 127/220V

-  **Dicroica LED**
SUPERLED
POWERLED
E27 127/220V
GZ10 127/220V
GU5,3 12V

obs: os produtos são sujeitos a desenvolvimento contínuo e por isso sofrem pequenas alterações sem aviso prévio.
obs: products are subject to continuous development and therefore suffer minor changes without notice.
obs: los productos están sujetas a continua evolución, por consiguiente, sufren cambios de menor importancia sin previo aviso.

Mikonos

**Spot orientável multilâmpadas
com controle de ofuscamento**

**Adjustable spot multi-lamps
with glare control**

**Spot orientable multi-lámparas
con control antideslumbrante**





lâmpadas lamps lámpadas	acessórios accessories accesorios	acabamento finish acabado	fixação fixation fijación	material construction construcción
QPAR30 HI-PAR30 QR111 HI-R111 HIT-CRI LED	filtros coloridos filtro UV filtro satinado grelhas anti-ofuscantes chromatic filters UV filter satin filter anti-glare combs filtros cromáticos filtro UV filtro satinado rejillas anti-reflejo	pintura epóxi epoxy powder paint finished acabados en pintura epoxi BF PF ZP	trilho Altrac trilho Altrac-Pro 3 circuitos canopla caixa porta equipamentos Altrac track Altrac-Pro 3 circuit track canopy equipment box riel Altrac riel Altrac-Pro 3 encenidos base caja porta-equipo	alumínio repuxado alumínio extrusado plástico termoresistente spun-aluminum extruded aluminum thermo resistant plastic aluminio repujado aluminio extrudido plástico termo resistente

Mikonos

 HIT-CRI 70/150W
G12 - 220V

 15, 16, 17

 HI-PAR30 35/70W
E27 - 220V









LSA 09571(15°)
LSA 09573(30°)
LSA 09575(60°)

LSA 09572(15°)
LSA 09574(30°)
LSA 09576(60°)

PRO 09572(15°)
PRO 09574(30°)
PRO 09576(60°)

LSA 09565

LSA 09566

PRO 09566

 QPAR30 50/75W
E27 - 127/220V



 HI-R111 35/70W
GX8,5 - 220V







LSA 09563

LSA 09564

PRO 09563

LSA 09569

LSA 09570

PRO 09570

 QR111 50/100W
G53 - 12V









LSA 09567

LSA 09568

PRO 09568



Filtros
Filters
Filtros



Grelha Radial
Radial Comb
Rejilla Radial



Honey Comb

LSA 90204
 •todos os projetores
 •all projectors
 •todos proyectores

LSA 90203
 •todos os projetores
 •all projectors
 •todos proyectores

LSA 90225
 •todos os projetores
 •all projectors
 •todos proyectores

Mikonos

Spot orientável multilâmpadas novas versões

Adjustable spot multi-lamps new versions

Spot orientable multi-lámparas nuevas versiones



lâmpadas lamps lámpadas	acessórios accessories accesorios	acabamento finish acabado	fixação fixation fijación	material construction construcción
QPAR38 QR70 QPAR16 QR-CB51 QPAR20 HI-PAR20 LED	<p>filtros coloridos filtro UV filtro satinado grelhas anti-ofuscantes</p> <p>chromatic filters UV filter satin filter anti-glare combs</p> <p>filtros cromáticos filtro UV filtro satinado rejillas anti-reflejo</p>	<p>pintura epóxi epoxy powder paint finished acabados en pintura epoxi</p> <p><input type="checkbox"/> BF <input type="checkbox"/> PF <input type="checkbox"/> ZP</p>	<p>trilho Altrac trilho Altrac-Pro 3 circuitos canopla caixa porta equipamentos</p> <p>Altrac track Altrac-Pro 3 circuit track canopy equipment box</p> <p>riel Altrac riel Altrac-Pro 3 encenidos base caja porta-equipo</p>	<p>alumínio repuxado alumínio extrusado plástico termoresistente</p> <p>spun-aluminum extruded aluminum thermo resistant plastic</p> <p>aluminio repujado aluminio extrudido plástico termo resistente</p>

Mikonos

QPAR38 90W
E27 - 127/220V



TC-TSE - 23W
E27 - 127/220V

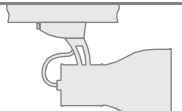
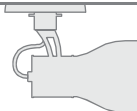
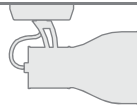
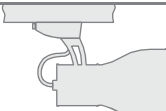
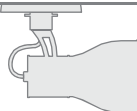
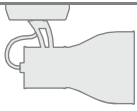

LSA 09747

LSA 09748

PRO 09748

LSA 09737

LSA 09720

PRO 09720

HI-PAR20 35W
E27 - 220V



QPAR20 50W
E27 - 127/220V

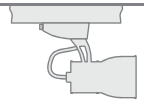
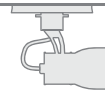
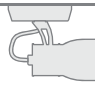
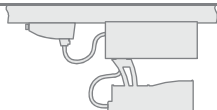
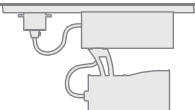
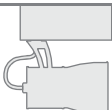

LSA 09595

LSA 09596

PRO 09596

LSA 09597

LSA 09598

PRO 09598

QR70 50W
Ba 15D - 12V



QPAR16 50W
GZ10 - 127/220V

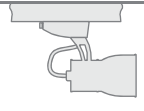
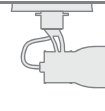
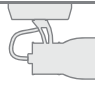
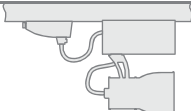
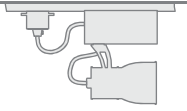
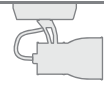

LSA 09738

LSA 09721

PRO 09721

LSA 09742

LSA 09741

PRO 09741

QR-CB51 50W
GU 5,3 - 12V

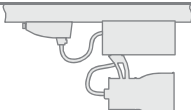
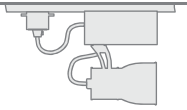
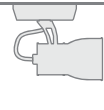

LSA 09740

LSA 09739

PRO 09739



Filtros
Filters
Filtros



Grelha Radial
Radial Comb
Rejilla Radial



Honey Comb

BTA 90201
•QPAR16
•QR-CB51

LSA 90221
•QPAR38
•TC-TSE

LSA 90207
•QR70
•QPAR20
•HI-PAR20

LSA 90206
•QPAR20
•QR70
•QPAR16
•QR-CB51

LSA 90223
•QPAR20
•QR70
•QPAR16
•QR-CB51

Aba

**Spot orientável multilâmpadas
com controle de ofuscamento**

**Adjustable spot multi-lamps
with glare control**

**Spot orientable multi-lâmparas
con control antideslumbrante**



lâmpadas lamps lámpadas	acessórios accessories accesorios	acabamento finish acabado	fixação fixation fijación	material construction construcción
QR70 QR-CB51 QPAR16 QPAR20 HI-PAR20 LED	filtros coloridos filtro UV filtro satinado grelhas anti-ofuscantes chromatic filters UV filter satin filter anti-glare combs filtros cromáticos filtro UV filtro satinado rejillas anti-reflejo	pintura epóxi epoxy powder paint finished acabados en pintura epoxi BF PF ZP	trilho Altrac trilho Altrac-Pro 3 circuitos canopla caixa porta equipamentos Altrac track Altrac-Pro 3 circuit track canopy equipment box riel Altrac riel Altrac-Pro 3 encenidos base caja porta-equipos	alumínio repuxado alumínio extrusado plástico termoresistente spun-aluminum extruded aluminum thermo resistant plastic aluminio repujado aluminio extrudido plástico termo resistente

Aba

QR-CB51 50W
GV5,3 - 12V

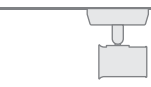

LSA 09585



LED

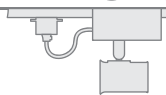

LSA 09586

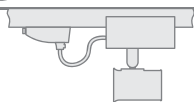

PRO 09586

QPAR16 50W
GZ10 - 127/220V

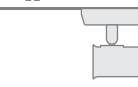

LSA 09587



LED

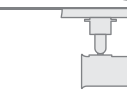

LSA 09588

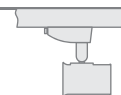

PRO 09588

QR48 20W
GU4 - 12V

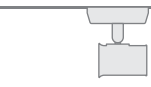

LSA 09583



LED

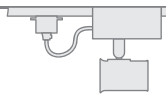

LSA 09584

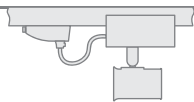

PRO 09584

QR70 50W
Ba 15D - 12V

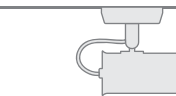

LSA 09593

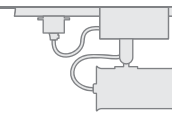

LSA 09594

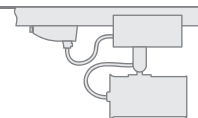

PRO 09594

QPAR20 50W
E27 - 127/220V

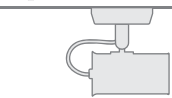

LSA 09589



LED

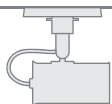

LSA 09590

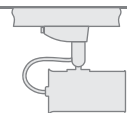

PRO 09590

HI-PAR20 35W
E27 - 220V

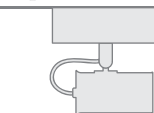

LSA 09591

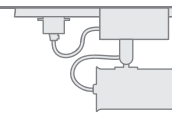

LSA 09592

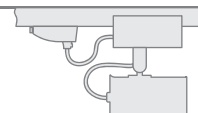

PRO 09592



 **Filtros**
Filters
Filtros

BTA 90195
•QR48

LSA 90201
•QR-CB51
•QPAR16
•QR48

LSA 90207
•QPAR20
•HI-PAR20
•QR70

 **Grelha Radial**
Radial Comb
Rejilla Radial

LSA 90205
•QR48
•QPAR16
•QR-CB51

LSA 90206
•QPAR20
•HI-PAR20
•QR70

 **Honey Comb**

LSA 90223
•QPAR20
•HI-PAR20
•QR70

LSA 90222
•QR48
•QPAR16
•QR-CB51

Dino

Spot orientável multilâmpadas com controle de ofuscamento

Adjustable spot multi-lamps with glare control

Spot orientable multi-lámparas con control antideslumbrante



lâmpadas lamps lámpadas	acessórios accessories accesorios	acabamento finish acabado	fixação fixation fijación	material construction construcción
QPAR30 HI-PAR30 QR111 HI-R111 HIT-CRI LED	filtros coloridos filtro UV filtro satinado grelhas anti-ofuscantes chromatic filters UV filter satin filter anti-glare combs filtros cromáticos filtro UV filtro satinado rejillas anti-reflejo	pintura epóxi epoxy powder paint finished acabados en pintura epoxi BF PF ZT	trilho Altrac e Altrac-Pro trilho Minitondo canopla caixa porta equipamentos Altrac and Altrac-Pro track Minitondo track canopy equipment box riel Altrac y Altrac-Pro riel Minitondo base caja porta-equipos	alumínio repuxado alumínio extrusado plástico termoresistente spun-aluminum extruded aluminum thermo resistant plastic aluminio repujado aluminio extrudido plástico termo resistente

Dino

QPAR30 70W
E27 - 127/220V



HI-PAR30 35/70W
E27 - 220V

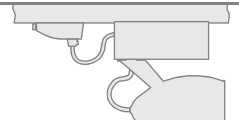
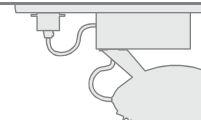
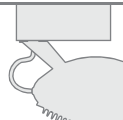
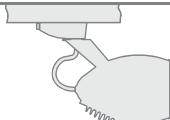
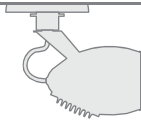
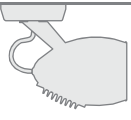

LSA 09267

LSA 09256

PRO 09256

LSA 09260

LSA 09275

PRO 09275

QR111 50/100W
G53 - 12V



HI-R111 30/70W
GX8,5 - 220V

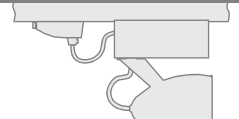
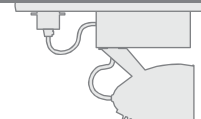
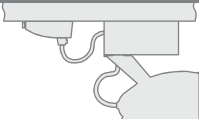
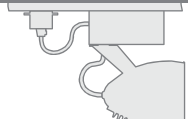

LSA 09259

LSA 09278

PRO 09278

LSA 09258

LSA 09279

PRO 09279

HIT-CRI 70/150W
G17 - 220V

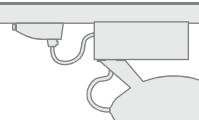
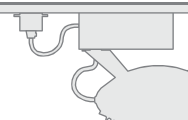
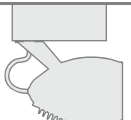

LSA 09271 (15°)
LSA 09272 (30°)
LSA 09273 (60°)

LSA 09257 (15°)
LSA 09268 (30°)
LSA 09269 (60°)

PRO 09257 (15°)
PRO 09268 (30°)
PRO 09269 (60°)



Honey Comb

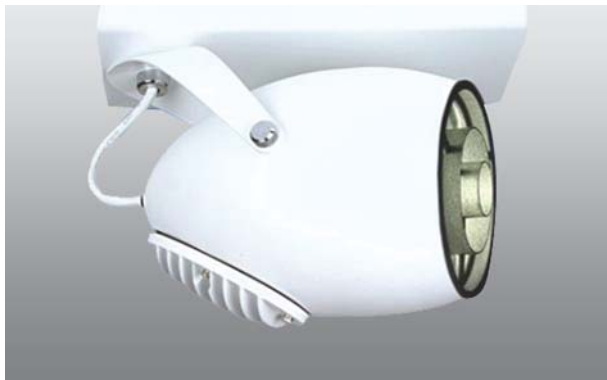

Filtros
Filters
Filtros



Grelha Radial
Radial Comb
Rejilla Radial



Honey Comb

LSA 90186
•HIT-CRI

LSA 90187
•QR111
•HI-R111

LSA 90188
•QPAR30
•HI-PAR30

LSA 90185
•HIT-CRI
•HI-PAR30
•QPAR30

LSA 90200
•QR111
•HI-R111

LSA 90224
•HIT-CRI
•HI-PAR30
•QPAR30

Dinomed Minidino

Altena Plus

Iluminação diferenciada e exclusiva

**Spot orientável multilâmpadas
com controle de ofuscamento**

**Adjustable spot multi-lamps
with glare control**

**Spot orientable multi-lámparas
con control antideslumbrante**



lâmpadas
lamps
lámpadas

QPAR20
HI-PAR20
QR70
HIT-CRI
QR-CB51
LED

acessórios
accessories
accesorios

filtros coloridos
filtro UV
filtro satinado
grelhas anti-ofuscantes

chromatic filters
UV filter
satin filter
anti-glare combs

filtros cromáticos
filtro UV
filtro satinado
rejillas anti-reflejo

acabamento
finish
acabado

pintura epóxi
epoxy powder paint finished
acabados en pintura epoxi

BF PF ZT

fixação
fixation
fijación

trilho Altrac e Altrac-Pro
trilho Minitondo
canopla
caixa porta equipamentos

Altrac and Altrac-Pro track
Minitondo track
canopy
equipment box

riel Altrac y Altrac-Pro
riel Minitondo
base
caja porta-equipos

material
construction
construcción

alumínio repuxado
alumínio extrusado
plástico termoresistente

spun-aluminum
extruded aluminum
thermo resistant plastic

aluminio repujado
aluminio extrudido
plástico termo resistente

Dinomed / Minidino

QPAR20 50W
E27 - 127/220V



HI-PAR20 35W
E27 - 220V

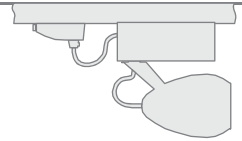
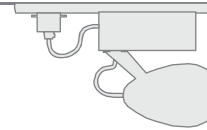
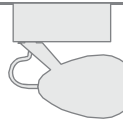
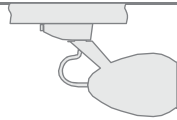
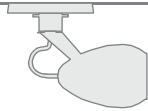
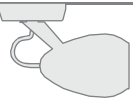

LSA 09266

LSA 09265

PRO 09265

LSA 09276

LSA 09277

PRO 09277

QR70 50W
Ba 15D - 12V



QR-CB51 50W
GU5,3 - 12V

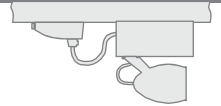
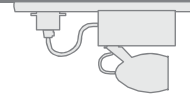
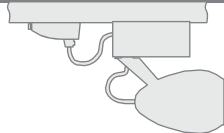
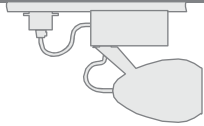

LSA 09310

LSA 09309

PRO 09309

LSA 09280

LSA 09262

PRO 09280

LSA 09261
(remoto)

LSA 09264
(Minitondo)

HIT-CRI 20W
PGJ5 - 220V



QR-CB51 50W
GU5,3 - 12V

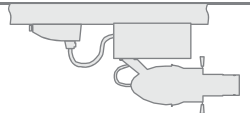
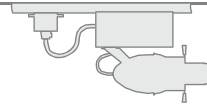
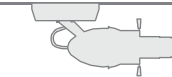
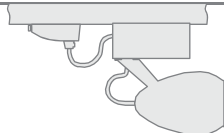
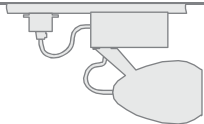
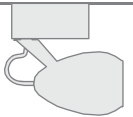

LSA 09474 (20°)
LSA 09475 (40°)
LSA 09476 (60°)

LSA 09471 (20°)
LSA 09472 (40°)
LSA 09473 (60°)

PRO 09471 (20°)
PRO 09472 (40°)
PRO 09473 (60°)

LSA 09491

LSA 09494

PRO 09494

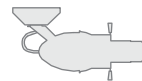

remoto
remote
remoto
LSA 09490

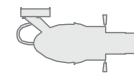

minitondo
LSA 09493

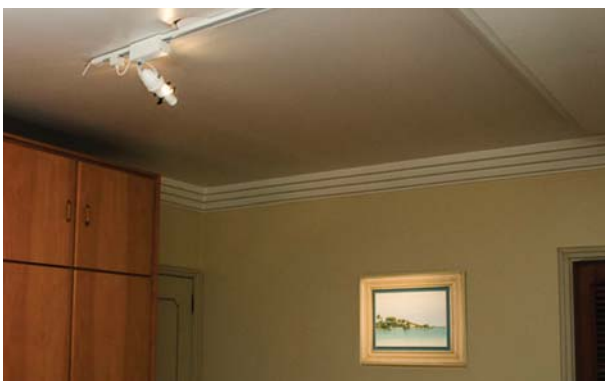

Filtros
Filters
Filtros



Grelha Radial
Radial Comb
Rejilla Radial



Honey Comb

BTA 90201
•QR-CB51

LSA 90220
•QPAR20
•HI-PAR20
•QR70
•HIT-CRI

LSA 90219
•QPAR20
•HI-PAR20
•QR70
•HIT-CRI

LSA 90205
•QR-CB51

LSA 90222
•QR-CB51

Rhodes / Pulsar

Spot orientável com vidro de segurança

Adjustable spot with protection glass

Spot orientable con cristal de seguridad



lâmpadas lamps lámpadas	acessórios accessories accesorios	acabamento finish acabado	fixação fixation fijación	material construction construcción
QT-DE12 HIT-DE	filtro UV filtro satinado	pintura epóxi epoxy powder paint finished acabados en pintura epoxi BF PF ZP	trilho Altrac trilho Altrac-Pro 3 circuitos canopla caixa porta equipamentos	alumínio extrusado plástico termoresistente vidro temperado
	UV filter satin filter		Altrac track Altrac-Pro 3 circuit track canopy equipment box	extruded aluminum thermo resistant plastic tempered glass
	filtro UV filtro satinado		riel Altrac riel Altrac-Pro 3 encenidos base caja porta-equipo	aluminio extrudido plástico termo resistente vidrio templado

Rhodes/ Pulsar

QT-DE12 300W
R7s - 127/220V

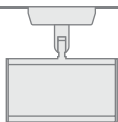

LSA 09579

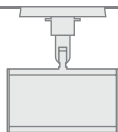

LSA 09580

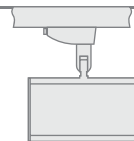

PRO 09580

HIT-DE 70/150W
RX7s - 220V

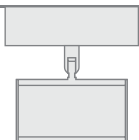

LSA 09577 (70W)
LSA 09663 (150W)

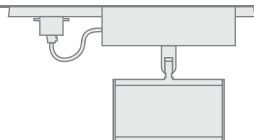

LSA 09578 (70W)
LSA 09664 (150W)

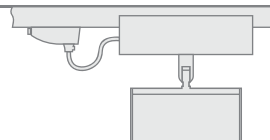

PRO 09578 (70W)
PRO 09664 (150W)

HIT-DE 70/150W
RX7s - 220V

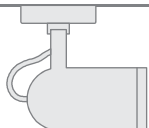

LST 516 04 C (70W)
LST 516 05 C (70W)
LST 516 09 C (70W)
LST 517 04 C (150W)
LST 517 05 C (150W)
LST 517 09 C (150W)

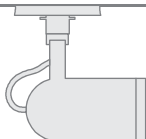

LST 516 14 PL (70W)
LST 516 15 PL (70W)
LST 516 19 PL (70W)
LST 517 14 PL (150W)
LST 517 15 PL (150W)
LST 517 19 PL (150W)

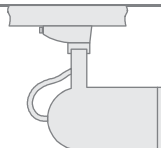

PRO 516 14 PL (70W)
PRO 516 15 PL (70W)
PRO 516 19 PL (70W)
PRO 517 14 PL (150W)
PRO 517 15 PL (150W)
PRO 517 19 PL (150W)

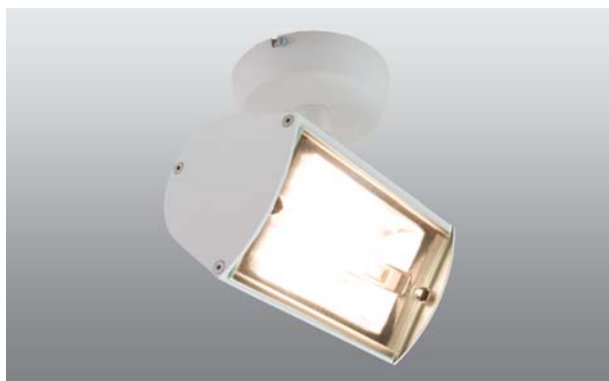

Filtros
Filters
Filtros

LSA 90213 (Rhodes)
•HIT-DE
•QT-DE12

LSA 90202 UV (Pulsar)
•HIT-DE
•QT-DE12

Mega

Spot orientável para lâmpada PAR

Adjustable spot for PAR lamps

Spot orientable para lâmpara PAR



QPAR20 - 50W
E27 - 127/220V



LED

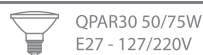

QPAR30 50/75W
E27 - 127/220V



LED

LSA 00110 C

LSA 00110 PL

PRO 00110

LSA 00111 C

LSA 00111 PL

PRO 00111

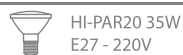

HI-PAR20 35W
E27 - 220V



HI-PAR30 35/70W
E27 - 220V

LSA 09851

LSA 09852

PRO 09852

LSA 09352

LSA 09353

PRO 09353

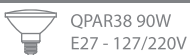

QPAR38 90W
E27 - 127/220V



LED

LSA 00112 C

LSA 00112 PL

PRO 00112

lâmpadas
lamps
lámpadas

QPAR20
HI-PAR20
QPAR30
HI-PAR30
QPAR38
LED

acabamento
finish
acabado

pintura epóxi
epoxy powder paint finished
acabados en pintura epoxi

BE PF ZT

fixação
fixation
fijación

trilho Altrac e Altrac-Pro
canopla
caixa porta equipamentos

Altrac and Altrac-Pro track
canopy
equipment box

riel Altrac y Altrac-Pro
base
caja porta-equipos

material
construction
construcción

alumínio repuxado
alumínio extrusado
plástico termoresistente
spun-aluminum
extruded aluminum
thermo resistant plastic
aluminio repujado
aluminio extrudido
plástico termo resistente

Piccolo

Spot orientável
Adjustable spot
Spot orientable



QPAR20 50W / QPAR30 75W / R63 40/60W
E27 - 127/220V



LED



POP 01009 CP



POP 01009 PL



POP 01009 2



QR-CB35 35W / QR-CB51 50W
GV5,3 - 12V



LED

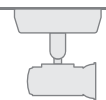

LSA 09870

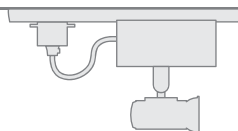

LSA 09869

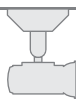

PRO 09871



LSA 09868



lâmpadas
lamps
lámpadas

QPAR20
QPAR30
R63
QR-CB35
QR-CB51
LED

acabamento
finish
acabado

pintura epóxi
epoxy powder paint finished
acabados en pintura epoxi

BF PF ZT

fixação
fixation
fijación

trilho Altrac
trilho Minitondo
canopla e caixa porta equipamentos

Altrac track
Minitondo track
canopy and equipment box

riel Altrac
riel Minitondo
base y caja porta-equipo

material
construction
construcción

alumínio repuxado
aluminio extrusado
plástico termoresistente

spun-aluminum
extruded aluminum
thermo resistant plastic

aluminio repujado
aluminio extrudido
plástico termo resistente

Minis

Spot orientável baixa tensão

Adjustable spot low tension

Spot orientable baja tension



Jupiter

Minimo 50

Cone 50

Cup 50

Control



BTA 06356

BTA 09533

LSA 09858

LSA 09855

LSA 09235

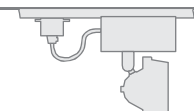
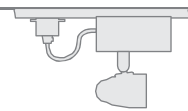
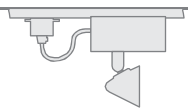
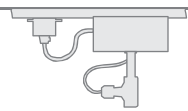
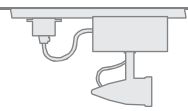

BTA 06359

BTA 09535

LSA 09857

LSA 09854

LSA 09234

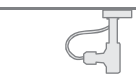

BTA 06358

BTA 09534

LSA 09856

LSA 09853

LSA 09876

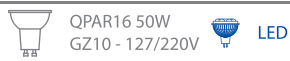

LSA 06346



LSA 06348



LSA 06347

lâmpadas
lamps
lámpadas

QR-CB51
QPAR16
QR111
LED

acabamento
finish
acabado

pintura epóxi
epoxy powder paint finished
acabados en pintura epoxi



fixação
fixation
fijación

trilhos Altrac e Minitondo
canopla

Altrac and Minitondo tracks
canopy

rieles Altrac y Minitondo
base

material
construction
construcción

aluminio repuxado
aluminio extrusado
plástico termoresistente
spun-aluminum
extruded aluminum
thermo resistant plastic
aluminio repujado
aluminio extrudido
plástico termo resistente

Minis

Spot orientável baixa tensão

Adjustable spot low tension

Spot orientable baja tension



Supervip

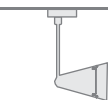

BTT 48914 U BF
BTT 48915 U PF
BTT 48919 U ZT



Vip

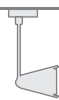

BTT 48610 U ZT
BTT 48614 U BF
BTT 48615 U PF



Elite



BTT 49314 U BF
BTT 49315 U PF
BTT 49319 U ZT



Cone 35



LSA 09867

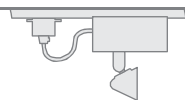

LSA 09866



LSA 09865



Cup 35



LSA 09864

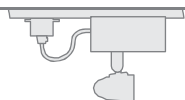

LSA 09863



LSA 09862



Minimo 35

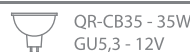

LSA 09861

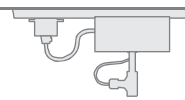

LSA 09860



LSA 09859



Minithor 35



LSA 09849

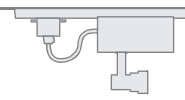

LSA 09850



LSA 09848

lâmpadas
lamps
lámpadas

QR-CB51
QR-CB35
LED

acabamento
finish
acabado

pintura epóxi
epoxy powder paint finished
acabados en pintura epoxi

BF PF ZT

fixação
fixation
fijación

trilhos Altrac e Minitondo
canopla

Altrac and Minitondo tracks
canopy

riles Altrac y Minitondo
base

material
construction
construcción

alumínio repuxado
alumínio extrusado
plástico termoresistente
spun-aluminum
extruded aluminum
thermo resistant plastic
alumínio repujado
alumínio extrudido
plástico termo resistente

Thor

Spot orientável multilâmpadas

Multi-lamps adjustable spot

Spot orientable multi-lâmpara



lâmpadas lamps lámpadas	acessórios accessories accesorios	acabamento finish acabado	fixação fixation fijación	material construction construcción
QPAR30 HI-PAR30 QPAR20 HI-PAR20 QR111 HI-R111 LED	filtros coloridos filtro UV grelhas anti-ofuscantes chromatic filters UV filter anti-glare combs filtros cromáticos filtro UV rejillas anti-reflejo	pintura epóxi epoxy powder paint finished acabados en pintura epoxi BF PF ZT	trilho Altrac e Altrac-Pro trilho Minitondo canopla caixa porta equipamentos Altrac and Altrac-Pro track Minitondo track canopy equipment box riel Altrac y Altrac-Pro riel Minitondo base caja porta-equipo	alumínio repuxado alumínio extrusado plástico termoresistente spun-aluminum extruded aluminum thermo resistant plastic aluminio repujado aluminio extrudido plástico termo resistente

Thor

QPAR20 50W
E27 - 127/220V



HI-PAR20 35W
E27 - 220V



LSA 09293

LSA 09292

PRO 09292

LSA 09749

LSA 09750

PRO 09750

QPAR30 75W
E27 - 127/220V



HI-PAR30 30/75W
E27 - 220V



LSA 09291

LSA 09290

PRO 09290

LSA 09350

LSA 09351

PRO 09351

QR111 50/100W
GU5,3 - 12V



HI-R111 35/70W
GX8,5 - 220V



LSA 09296

LSA 09295
(Minitondo)

LSA 09294

PRO 09294

LSA 09558

LSA 09513

PRO 09513



Filtros
Filters
Filtros



Grelha Radial
Radial Comb
Rejilla Radial

- LSA 90211
 - QPAR20
 - HI-PAR20
- LSA 90212
 - QPAR30
 - HI-PAR30
- LSA 90183
 - QR111
 - HI-R111

- LSA 90209
 - QPAR20
 - HI-PAR20
- LSA 90208
 - QR111
 - HI-R1111

- LSA 90210
- QPAR30
- HI-PAR30

Thor / Minithor

Spot orientável multilâmpadas

Multi-lamps adjustable spot

Spot orientable multi-lâmpara



lâmpadas lamps lámpadas	acessórios accessories accesorios	acabamento finish acabado	fixação fixation fijación	material construction construcción
QR70 QR-CB51 QPAR16 QR-CB35 AR111-GZ10 LED	<p data-bbox="344 1809 571 1886">filtros coloridos filtro UV grelhas anti-ofuscantes</p> <p data-bbox="344 1935 501 2011">chromatic filters UV filter anti-glare combs</p> <p data-bbox="344 2065 507 2136">filtros cromáticos filtro UV rejillas anti-reflejo</p>	<p data-bbox="676 1809 944 1886">pintura epóxi epoxy powder paint finished acabados en pintura epoxi</p> <p data-bbox="676 1890 794 1912">[BF] [PF] [ZT]</p>	<p data-bbox="986 1809 1241 1912">trilho Altrac e Altrac-Pro trilho Minitondo canopla caixa porta equipamentos</p> <p data-bbox="986 1935 1193 2033">Altrac Altrac-Pro track Minitondo track canopy equipment box</p> <p data-bbox="986 2065 1181 2163">riel Altrac y Altrac-Pro riel Minitondo base caja porta-equipos</p>	<p data-bbox="1311 1809 1544 1886">alumínio repuxado alumínio extrusado plástico termoresistente</p> <p data-bbox="1311 1935 1532 2011">spun-aluminum extruded aluminum thermo resistant plastic</p> <p data-bbox="1311 2065 1532 2136">aluminio repujado aluminio extrudido plástico termo resistente</p>

Thor / Minithor

QR70 50W
Ba 15D - 12V

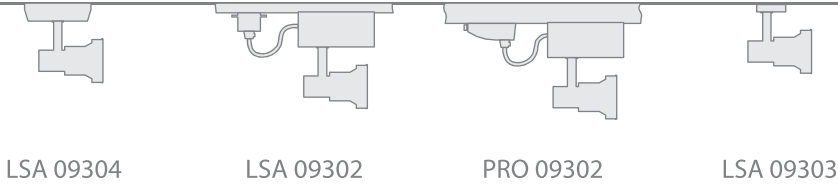

LSA 09304 LSA 09302 PRO 09302 LSA 09303

QR-CB51 50W
GU5,3 - 12V



QPAR16 50W
GZ10 - 127/220V



LSA 09300
LSA 09299
(Minitondo) LSA 09298 PRO 09298 LSA 09666
LSA 09668
(remoto) LSA 09667 PRO 09667

QR-CB35 35
GU5,3 - 12V

AR111 60W
GZ10 - 127/220V



LSA 09849 LSA 09850 LSA 09848 LSA 09515 LSA 09518 PRO 09518



Filtros
Filters
Filtros



Grelha Radial
Radial Comb
Rejilla Radial



Honey Comb

LSA 90184 BTA 90201
•QR70 •QR-CB51
 •QPAR16

LSA 90206 LSA 90201 LSA 90222
•QR70 •QR-CB51 •QR-CB51
 •QPAR16 •QPAR16

BTA 90196
•QR-CB51
•QPAR16

Paros / Nixos

Spot orientável série competition

Adjustable spot competition series

Spot ajustable serie competition



 QPAR20 - 50W
E27 - 127/220V

 LED

 QPAR30 75W
E27 - 127/220V

 LED



LSA 09695

LSA 09694

LSA 09697

LSA 09696

 QR-CB51 20/50W
GU5,3 - 127/220V

 LED

 QR-CB51 50W
GU5,3 - 12V

 LED

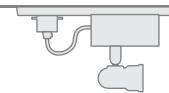

LSA 09691

LSA 09688

LSA 09692

LSA 09689

 QPAR16 50W
GZ10 - 127/220V

 LED



LSA 09693

LSA 09690

lâmpadas
lamps
lámpadas

acabamento
finish
acabado

fixação
fixation
fijación

material
construction
construcción

QPAR20
QPAR30
QR-CB51
QPAR16
LED

pintura epóxi
epoxy powder paint finished
acabados en pintura epoxi

trilho Altrac
canopla

Altrac track
canopy

riel Altrac
base

alumínio repuxado
aluminio extrusado
plástico termoresistente

spun-aluminum
extruded aluminum
thermo resistant plastic

aluminio repujado
aluminio extrudido
plástico termo resistente



Acessórios Para projetores

Acessórios Para projetores

Acessórios Para projetores

Projektor Imagem Imagem	Honey Comb	Grelha Radial Radial Comb Rejilla Radial	Filtro Filter filtro
Mini Mikonos	LSA 90223	LSA 90206	LSA 90207
Mikonos	LSA 90225	LSA 90203	LSA 90204
Mini Thor	LSA 90222	BTA 90196	BTA 90201
Thor QR70		LSA 90206	LSA 90184
Thor QPAR20/HI-PAR20		LSA 90209	LSA 90211
Thor QPAR30/JI-PAR30		LSA 90210	LSA 90212
Thor QR111/HI-R111		LSA 90208	LSA 90183
Mini Dino	LSA 90222	LSA 90205	BTA 90201
Dino Med		LSA 90219	LSA 90220
Dino HIT-CRI	LSA 90224	LSA 90185	LSA 90186
Dino QPAR30/HI-PAR30	LSA 90224	LSA 90185	LSA 90188
Dino QR111/HI-R111		LSA 90200	LSA 90187
Aba QR48	LSA 90222	LSA 90205	BTA 90195
Aba QR-CB35/QR-CB51/QPAR16	LSA 90222	LSA 90205	BTA 90201
Aba QR70/PAR20	LSA 90223	LSA 90206	LSA 90207

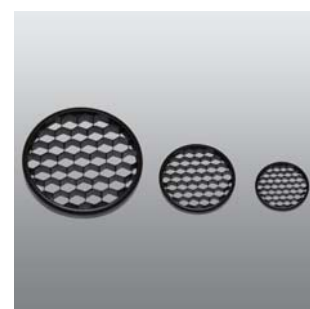

Honey Comb

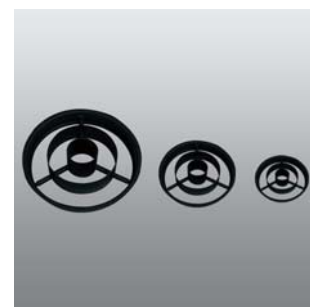

Radial

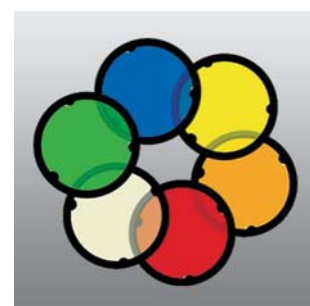

Filter

Altrac

Trilho eletrificado de um circuito

Single-Circuit Track

Riel de un encendido



características

features

características

sistema de iluminação em trilhos eletrificados com adaptadores (plugs) para acendimento de vários projetores (spots) ou luminárias.

track lighting system with adaptors for several projectors or luminaires. assures the displacement of the lights along the track.

sistema de iluminación en rieles con adaptadores para varios proyectores o luminarias. asegura el desplazamiento de las luces a lo largo del riel.

acabamento

finish

acabado

pintura epóxi
epoxy powder paint finished
acabados en pintura epoxi



material

construction

construcción

perfil de alumínio extrusado
perfis termoplásticos não inflamáveis
condutores de alumínio

extruded Aluminum profile
nonflammable thermoplastic profile
aluminum conductor

perfil de aluminio extruido
perfil de termoplástico no inflamable
conductor de aluminio

Sistema Altrac Mono
Altrac Mono System
Sistema Altrac Mono

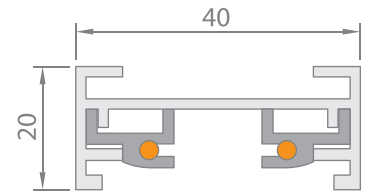

tensão nominal: 127V ou 220V
carga máxima: 127V=2200W
220V=4400W

nominal tension: 127V ou 220V
high power: 127V=2200W
220V=4400W

tensión nominal: 127V ou 220V
alta potencia: 127V=2200W
220V=4400W

TRA 00001 = trilho 1m track 1m riel 1m
TRA 00002 = trilho 2m track 2m riel 2m
TRA 00021 = trilho 3m track 3m riel 3m

conexões, fixações e suspensões

connections, fixations and suspensions

uniones, fijación y suspensiones

TRA 00009

adaptador 127V/220V
 127V/220V adaptor
 adaptador 127V/220V



BR
 PR
 ZT

TRA 00014

adaptador para transformador 12V
 12V transformer adaptor
 adaptador para transformador



BF
 PF
 ZT

TRA 00003

ponteira inicial e terminal
 initial and terminal cover box
 tapa inicial y terminal

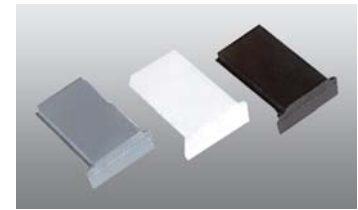

BR
 PR
 ZT

TRA 00004

conexão reta
 straight connection
 unión lineal



BR
 PR
 ZT

TRA 00005

conexão 90°
 90° connection
 unión 90°

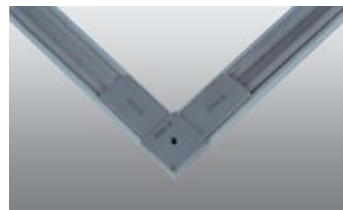

BR
 PR
 ZT

TRA 00006

conexão em "T"
 "T" connection
 unión en "T"



BR
 PR
 ZT

TRA 00007

conexão em cruz
 "X" connection
 unión en "X"



BR
 PR
 ZT

TRA 00008

fixador rente ao teto
 ceiling bracket fixer
 soporte de fijación al techo



BR
 PR
 ZT

TRA 00011 e TRA 00012 **hastes para sustentação**
 extension Wand
 soporte de fijación

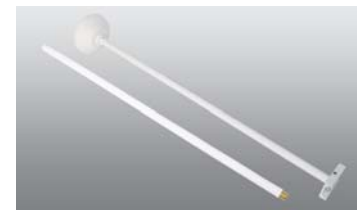

BF
 PF
 ZT

material
construction
 consctrucción

acabamento
finish
 acabado

acessórios
accessories
 accesorios

trilhos: perfil de alumínio, canaletas termoplásticas, condutores em alumínio.
conectores: em alumínio e termoplástico.
hastes: tubo de aço.

tracks: aluminum profile, thermoplastic channels, aluminum conductors.
connectors: aluminum and thermoplastic .
extension wand: steel tube.

rieles: perfil de aluminio, canales de termoplástico, condutores de aluminio.
conectores: aluminio y termoplástico.
soporte de fijación: tubo de acero.

trilhos em
pintura epóxi

epoxy powder coat
finish tracks

rieles acabados em
pintura epoxi

BR BF PR PF ZT

junções em plástico colorido
hastes pintadas em epóxi

colorful plastic joints epoxy
powder paint extension wands

uniones en plástico colorido
soportes de fijación en pintura epoxi

BF PF ZT

exemplo de aplicação

application example

ejemplo de aplicación

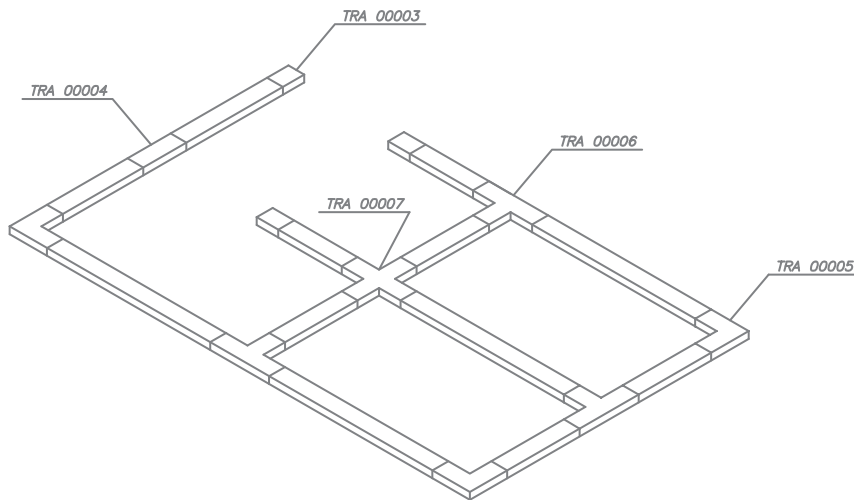

montagem das conexões

mounting connections

conexiones de montaje



- 1 - alinhar os trilhos;
- 2 - encaixar junção posterior;
- 3 - fixá-la com parafuso;
- 4 - fazer a conexão dos cabos na parte interna das conexões;
- 5 - colocar tampa de acabamento.

- 1 - align tracks;
- 2 - nest back mechanic joint;
- 3 - fix it with a screw;
- 4 - connect cables on the inside part of connections;
- 5 - place cover finish.

- 1 - alinear rieles;
- 2 - encajar unión mecánica posterior;
- 3 - fijala con tornillo;
- 4 - conectar los cables en la parte interna de las uniones;
- 5 - colocar la tapa final.

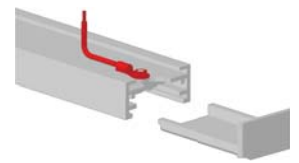

conexão reta
straight connection
unión lineal

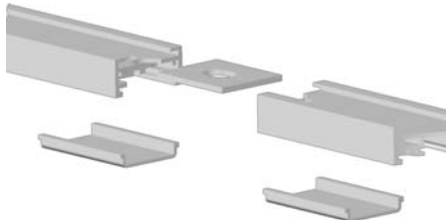

BR
PR
ZT

TRA 00004

conexão 90°
90° connection
90° unión

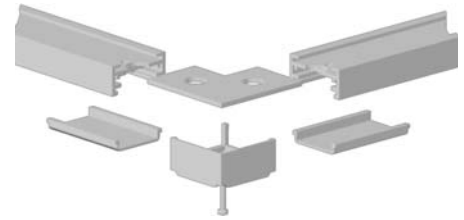

BR
PR
ZT

TRA 00005

conexão "T"
"T" connection
unión en "T"

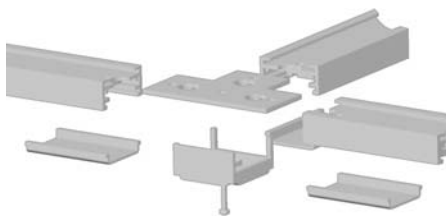

BR
PR
ZT

TRA 00006

conexão em cruz
"X" connection
unión en "X"

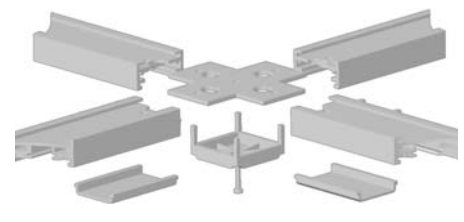

BR
PR
ZT

TRA 00007

ligação de rede elétrica e circuito

electrical connection and circuit

conexión de red eléctrica y encendido

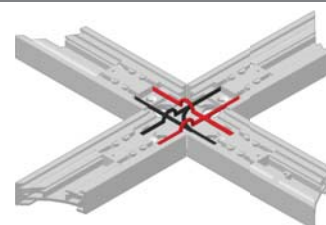
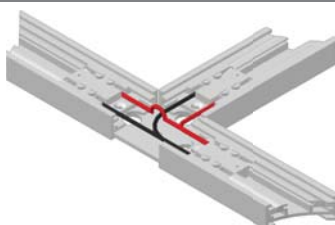
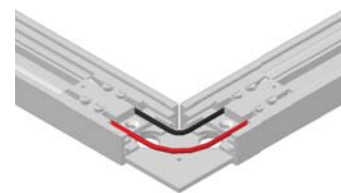
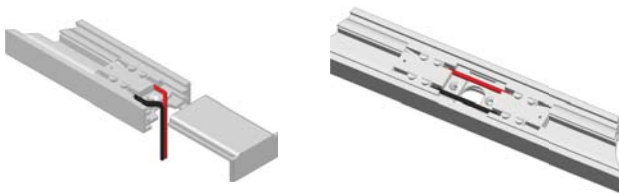

usar cabo de 5mm² para conexões

use 5mm² cable connections

usar cable de 5mm² para las conexiones

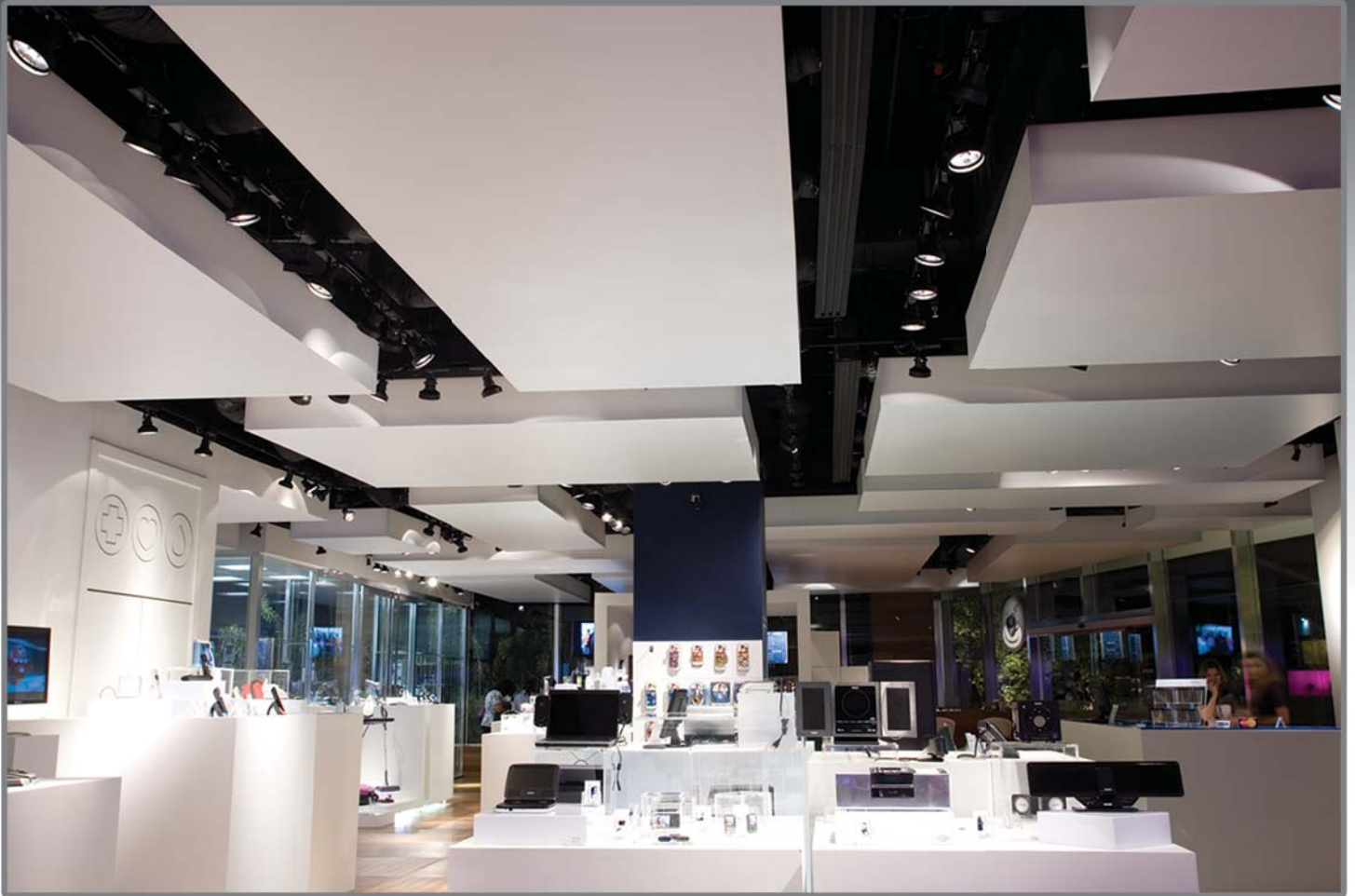

Sistema de trilhos com 3 circuitos

3 Circuits Track System

Sistema de rieles de 3 encendidos



TRILHOS

O sistema é um trilho eletrificado profissional de três circuitos. Fabricado por Altena, está em conformidade com as normas europeias de segurança, apresentando as seguintes vantagens:
Facilita o posicionamento de spots e projetores em qualquer local. Sua ampla gama de junções permite um grande número de composições geométricas em seus projetos.

ADAPTADOR

O adaptador – seletor de circuitos: Permite a utilização de todos os spots e projetores, fabricados pela Altena. Conecta facilmente qualquer projetor Altena, com um simples giro da mão, a qualquer um dos três circuitos.

TRACKS

The system is a professional 3-circuits electrified track. Manufactured by Altena, complies with European safety standards, presenting the following benefits:
Facilitates the placement of spots and projectors anywhere. Its wide range of joints allows a large number of geometric compositions in their projects.

ADAPTOR

The adapter - switch circuits: Allows the use of all spots and projectors, manufactured by Altena. Connects any projector easily Altena, with a simple turn of the hand, any one of the three circuits.

RIELES

El sistema es un riel profesional de vía electrificado de 3 encendidos. Fabricado por Altena, cumple con las normas Europeas de seguridad, y presenta las siguientes ventajas:
Facilita la colocación de anuncios y proyectores en cualquier lugar. Su amplia gama de articulaciones permite a un gran número de composiciones geométricas en sus proyectos.

ADAPTADOR

El adaptador – selector de encendidos: Permite el uso de todos los proyectores, fabricado por Altena. Se conecta fácilmente con un simple giro de la mano en cualquiera de los tres circuitos.



características

features

características

sistema de iluminação em trilhos eletrificados com adaptadores (plugs) para acendimento de vários projetores (spots) ou luminárias.

track lighting system with adaptors for several projectors or luminaires. assures the displacement of the lights along the track.

sistema de iluminación en rieles con adaptadores para varios proyectores o luminarias. asegura el desplazamiento de las luces a lo largo del riel.

acabamento

finish

acabado

pintura epóxi epoxy powder paint finished acabados en pintura epoxi

BR

BF

PR

PF

ZP

material

construction

construcción

perfil de alumínio extrusado perfis termoplásticos não inflamáveis condutores de alumínio

extruded Aluminum profile nonflammable thermoplastic profile aluminum conductor

perfil de alumínio extruido perfil de termoplástico no inflamable conductor de alumínio

Sistema Altrac PRO

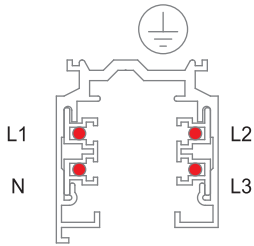

TRA 00034 = trilho 1m
TRA 00035 = trilho 2m
TRA 00036 = trilho 3m

BF PF

1m track riel 1m
2m track riel 2m
3m track riel 3m

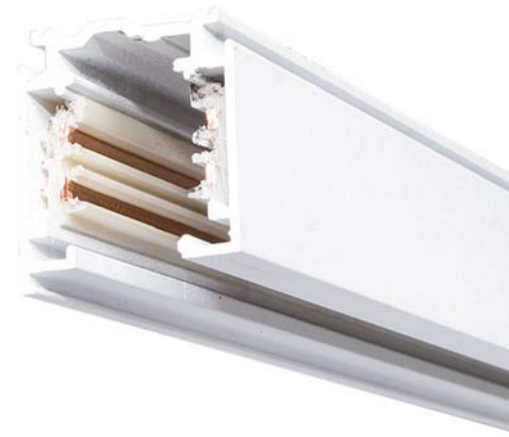

O neutro pode ser identificado pela saliência longitudinal do trilho.
 The neutral can be identified by longitudinal track salience.
 El neutro puede ser identificado por la prominencia longitudinal del riel.

Atenção: Ao instalar o trilho, conexões e adaptador, o neutro deverá estar sempre do mesmo lado.
 Attention: Installing the track, connections and adaptor, the neutral should always be on the same side.
 Atención: Cuando instalar el riel, las conexiones y el adaptador, el neutro deberá siempre estar en el mismo lado.

conexões

alimentador
 feeder
 alimentador



TRA 00037 - **direito** / right / derecho
 TRA 00038 - **esquerdo** / left / izquierdo

BR
 PR

connections

conexão "T"
 "T" connection
 conexión en "T"



TRA 00041 - **direita** / right / derecha
 TRA 00042 - **esquerda** / left / izquierda

BR
 PR

conexiones

conexão em linha
 linear connection
 conexión lineal



TRA 00039

tampa terminal
 outlet cover
 tapa final



BR
 PR

TRA 00040

conexão em 90°
 90° connection
 conexión 90°



TRA 00043 - **direito** / right / derecho
 TRA 00044 - **esquerdo** / left / izquierdo

BR
 PR

conexão em cruz
 "X" connection
 conexión "X"



TRA 00045

BR
 PR

adaptador / seletor de circuitos
 circuit adaptor / selector
 adaptador / selector de encendidos



BF
 PF

adaptador / seletor
 adaptor / selector
 adaptador / selector

o adaptador Altrac PRO permite a conexão de todos os projetores fabricados pela Altena. conexão com um simples giro da mão em qualquer circuito. mudança de cena usando os três circuitos.

Altrac Pro adaptor permits connection to all projectors made by Altena. Connection with a simple turn in any circuit in any circuit. Scene changes using 3-circuits.

El adaptador Altrac Pro permite la conexión a todos los proyectores fabricados por Altena. Conexión con un simple giro de la mano en cualquier encendido. Cambio de escena utilizando los 3 encendidos.

cortes dos trilhos
 track cuts
 cortes de riel

pintura epóxi
 epoxy powder paint finished
 acabados em pintura epoxi

acessórios
 accessories
 accesorios

todas as conexões acima são mecânicas e elétricas, não necessitando de cabos para conectar um segmento ao outro.

all connections above are mechanical and electrical, not requiring cables to connect a segment to another.

todas las conexiones arriba son mecánicas y eléctricas, y no requieren cables para conectar un segmento a otro.

esquema de montagem

mounting plan

esquema de montaje

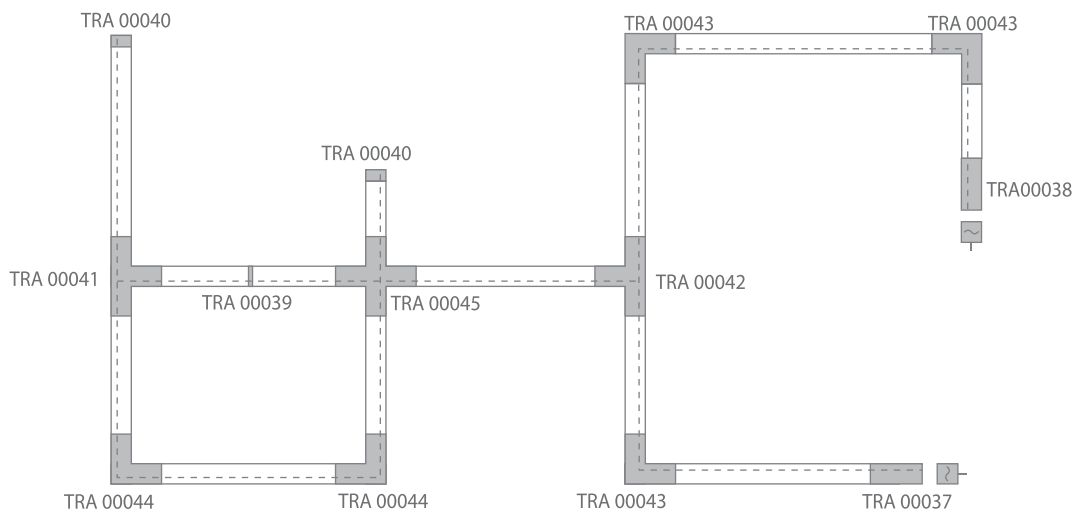

Vista refletida do teto (Desenho em planta)
 Reflected view of the ceiling (Drawing blueprint)
 Vista reflejada del techo (dibujo de plantas)

Linha de referência na parte posterior do trilho.
 Reference line on the back of the track.
 Referencia a la línea en la parte posterior del riel.

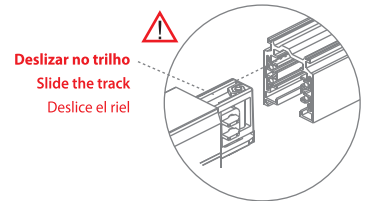

instalação - suspensão - fixação

instalation - suspension - fixation

instalación - suspensión - fijación

fixação direta no trilho
 Direct fixation on the track
 Soporte de fijación directa en el riel

os furos de distanciam 50cm uns dos outros, iniciando sempre a 25 cm das pontas.
 holes 50cm apart from each other, always starting at 25 cm from the tips.
 agujeros de 50 cm de distancia entre sí, siempre a partir de 25 cm desde la punta.

distâncias válidas para trilhos de 1, 2 e 3 metros
 for tracks of 1, 2 e 3 meters
 distancias para rieles de 1, 2 e 3 metros

TRA 00050
fixador de teto ou parede
 ceiling or wall fixer
 fijación de techo o pared

TRA 00047
haste rígida de 50 cm
 50cm extension wand
 brida de 50cm

TRA 00051
união mecânica em linha
 straight mechanic union
 unión mecánica linear

TRA 00048
fixador com cabo de aço micro regulável
 adjustable steel wire fixer
 fijación con cable de acero micro regulable

TRA 00049
estensão haste rígida de 50 cm
 50cm rigid extension wand
 brida rígida de 50cm

ligação elétrica

electrical connection

conexiones eletricas

ligação de circuito simples 220V / 220V
 simple circuit connection 220V / 220V
 conexión de encendido simple 220V / 220V

MAX.16A
 230V~16A, 3.7KW Class 1

Cada circuito 8,3A=1054W
 Each circuit 8,3A=1054W
 Cada encendido 8,3A=1054W

ligação de 3 circuitos - 380V / 220V
 3-Circuit connection - 380V / 220V
 conexión de 3 encendidos - 380V / 220V

MAX.16A
 230V~16A, 3.7KW Class 1

Cada circuito 5,3A=1166W
 Each circuit 5,3A=1166W
 Cada encendido 5,3A=1166W

ligação de 3 circuitos - 220V / 127V
 3-Circuit connection - 220V / 127V
 conexión de 3 encendidos - 220V / 127V

MAX.25A
 127V~25A, 3.7KW Class 1

Cada circuito 5,3A=1166W
 Each circuit 5,3A=1166W
 Cada encendido 5,3A=1166W

Minitondo

Trilho eletrificado 12V

Electrified track 12V

Riel electrificado 12V



características
features
características

**trilho monofásico de dimensões mínimas
para instalações em baixa tensão (12V).**

**lowest dimension single phase
track to low voltage installations.**

**riel monofásico de dimensiones mínimas
para instalaciones en baja tensión.**

acabamento
finish
acabado

pintura epóxi
epoxy powder paint finished
acabados en pintura epoxi

BF

PF

ZT

material
construction
construcción

perfil de alumínio extrusado
perfis termoplásticos não inflamáveis
condutores de cobre

extruded Aluminum profile
nonflammable thermoplastic profile
copper conductor

perfil de aluminio extruido
perfil de termoplástico no inflamable
conductor de cobre

Minitondo

Trilho eletrificado 12V

Electrified track 12V

Riel electrificado 12V

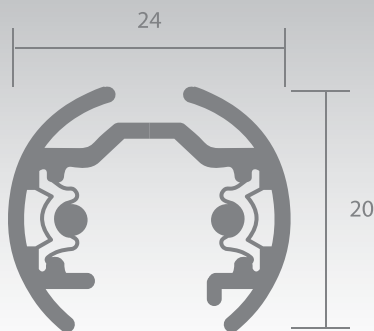

Minitondo é um trilho miniaturizado, monofásico que utiliza lâmpadas de baixa tensão. Foi idealizado para projetores de dimensões reduzidas que harmonizem com lâmpadas dicróicas etc.

Minitondo is a miniature track, single phased available for low voltage lamps. It was designed for commercial and residential projects where compact dimension projectors are recommended and houses dichroic lamps.

Minitondo es un riel en miniatura monofásico, que utiliza lámparas de baja tensión. Ha sido idealizado para proyectos comerciales y residenciales donde si recomiendan proyectores de dimensiones reducidas.

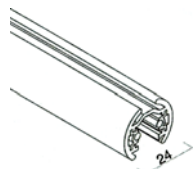

BTT 474 01 BF **trilho de 1m**
BTT 475 01 PF **1m track**
BTT 479 01 ZT **riel de 1m**

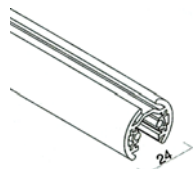

BTT 474 02 BF **trilho de 2m**
BTT 475 02 PF **2m track**
BTT 479 02 ZT **riel de 2m**

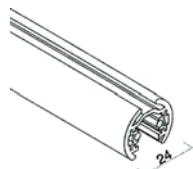

BTT 474 03 BF **trilho de 3m**
BTT 475 03 PF **3m track**
BTT 479 03 ZT **riel de 3m**

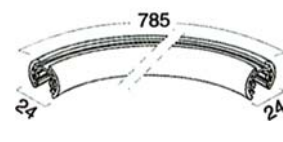

BTT 474 05 BF **trilho curvo**
BTT 475 05 PF **curved track**
BTT 479 05 ZT **riel curvado**

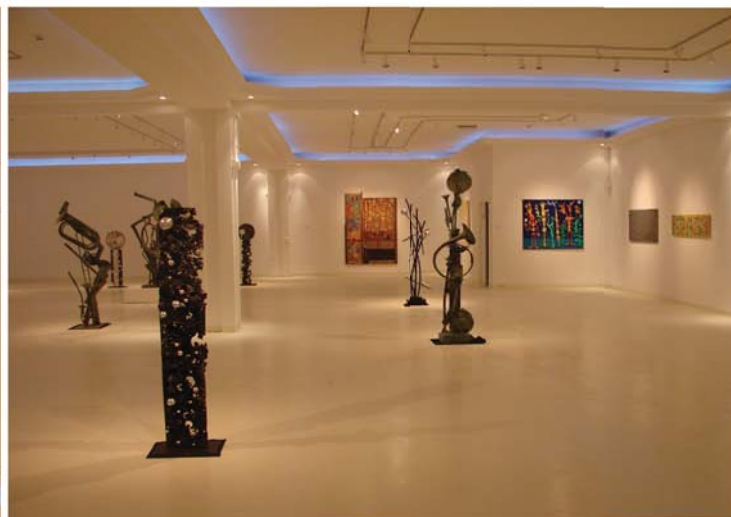

exemplos de montagem

mounting scheme



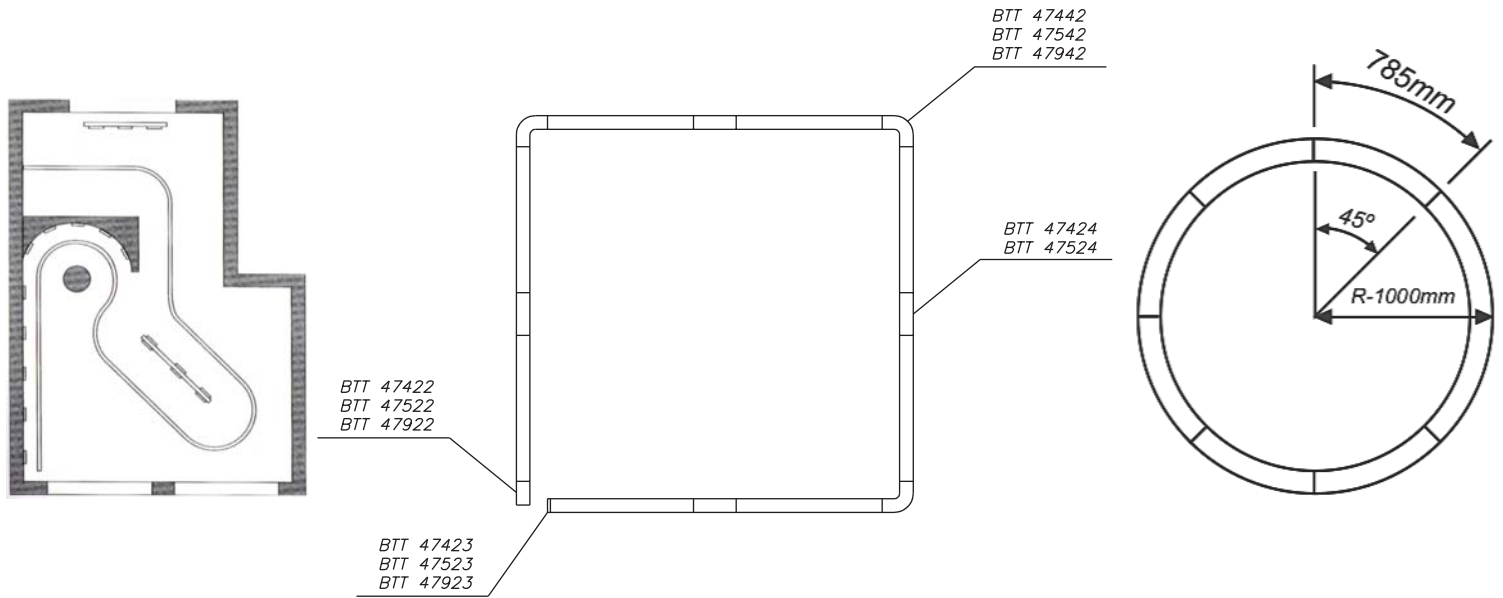



esquema de montaje

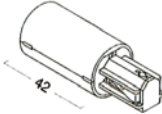
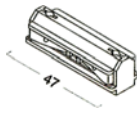
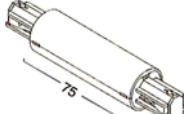

conexões

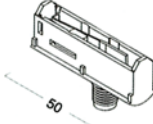
connections

conexiones

<p>BTT 474 22 [BF] BTT 475 22 [PF] BTT 479 22 [ZT]</p>  <p>alimentador de ponta cover feeder alimentador de punta</p>	<p>BTT 474 24 [BF] BTT 475 24 [PF]</p>  <p>junção linear straight connector unión linear</p>	<p>BTT 474 20 [BF] BTT 475 20 [PF] BTT 479 20 [ZT]</p>  <p>alimentador central central feeder alimentador central</p>
<p>BTT 474 42 [BF] BTT 475 42 [PF] BTT 479 42 [ZT]</p>  <p>junção 90° 90° connector unión 90°</p>	<p>BTT 474 31 U [BF] BTT 475 31 U [PF] BTT 479 31 U [ZT]</p>  <p>adaptador universal universal adaptor adaptador universal</p>	<p>BTA 09536 V1 - 200W / 127V [BF] BTA 09536 V2 - 200W / 220V [PF] [ZT]</p>  <p>transformador eletrónico electronic transformer transformador electrónico</p>
<p>BTT 474 37 [BF] BTT 475 37 [PF] BTT 479 37 [ZT]</p>  <p>cabo de sustentação supporting cable cable de sustentación</p>	<p>BTT 474 23 [BF] BTT 475 23 [PF] BTT 479 23 [ZT]</p>  <p>terminal terminal terminal</p>	<p>BTT 474 26 [BF] BTT 475 26 [PF] [ZT]</p>  <p>distanciador spacer distanciador</p>

material
construction
construcción

contatos em cobre
corpos em termoplástico
cabos de sustentação em aço

copper cut
thermoplastic body
steel extension wand

conductores de cobre
cuerpo en termoplástico
brida en acero

acabamento
finish
acabado

pintura epóxi
epoxy powder paint finished
acabados en pintura epoxi

[BF]
[PF]
[ZT]

nota
note
nota

o adaptador universal pode ser comprado avulso. nos spots Altena o adaptador já está incluso.



















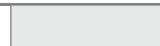
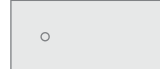

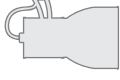
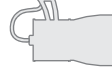

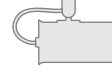

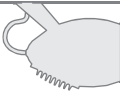
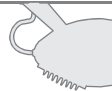
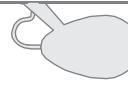

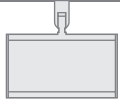







universal adaptor can be ordered separately. adaptor included in all Altena's spots.

el adaptador universal puede ser comprado por separado. en los proyectores Altena já está incluido.

dimensões

dimensions

dimensiones

canopla canopla canopla	plug Altrac	plug Altrac-Pro	caixa transf. eletronico	caixa equip. eletronico
 h=31  ø=120	 h=30  40x40	 h=30  85x40	 h=60  130x53	 h=67  180x108
Mikonos QPAR38/TC-TSE	Mikonos Maior HIT-CRI/QPAR30/HI-R111/QR111	Mikonos HI-PAR20	Mikonos Menor QR70/QPAR16/QR-CB51/QPAR20	Aba QR70/QPAR20
 ø=135 l=210 h=155	 ø=120 l=190 h=150	 ø=95 l=160 h=135	 ø=80 l=130 h=110	 ø=70 l=145 h=140
Aba QR-CB51/QPAR16/QR48	Dino QPAR30/HI-PAR30	Dino QR111/HI-R111/HIT-CRI	Dinomed QPAR20/HI-PAR20/QR70/HIT-CRI	Minidino QR-CB51
 ø=50 l=95 h=105	 ø=120 l=170 h=155	 ø=120 l=155 h=155	 ø=110 l=155 h=130	 ø=67 l=100 h=80
Minidino QR-CB51	Rhodes QT-DE12/HIT-DE	Mega QPAR20/HI-PAR20	Mega QPAR30/HI-PAR30	Mega QPAR38
 ø=35 l=190 h=80	 h=150 190x110	 ø=85 l=145 h=145	 ø=112 l=175 h=158	 ø=140 l=190 h=170
Piccolo QPAR20/QPAR30	Piccolo QR-CB51/QR-CB35	Júpiter QR-CB51/QPAR16	Mínimo 50 QR-CB51	Cone 50 QR-CB51
 ø=38 l=110 h=90	 ø=38 l=75 h=80	 ø=54 l=110 h=100	 ø=54 l=65 h=100	 ø=70 l=70 h=100
Cup 50 QR-CB51	Control QR111	Super Vip QR-CB51	Vip QR-CB51	Elite QR-CB51
 ø=60 l=90 h=100	 ø=115 l=85 h=125	 ø=80 l=100 h=140	 ø=52 l=75 h=125	 ø=52 l=75 h=125
Cone 35 QR-CB35	Cup 35 QR-CB35	Mínimo 35 QR-CB35	Minithor 35 QR-CB35	Thor QPAR20/HI-PAR20
 ø=50 l=55 h=90	 ø=45 l=65 h=90	 ø=43 l=58 h=100	 ø=38 l=65 h=75	 ø=70 l=130 h=105

dimensões

dimensions

dimensiones

Thor
QPAR30/HI_PAR30



l=160
h=125

Thor
QR111/HI-R111



l=160
h=130

Thor
QR70



l=112
h=110

Minithor 50
QR-CB51/QPAR16

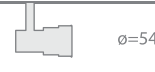

l=95
h=100

Paros
QPAR20



l=130
h=125

Paros
QPAR30



l=130
h=146

Nixos
QR-CB51/QPAR16



l=90
h=90

Pulsar
QT-DE12/HIT-DE

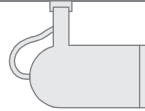

c=200
l=230
h=205

fotometria

photometry



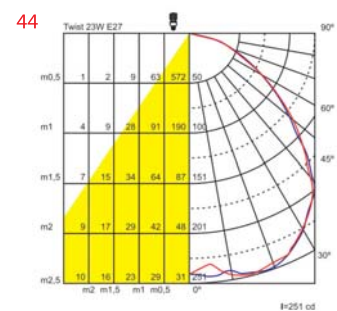
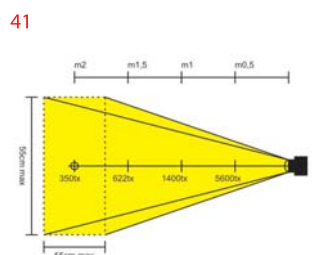
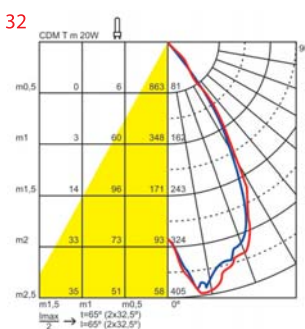
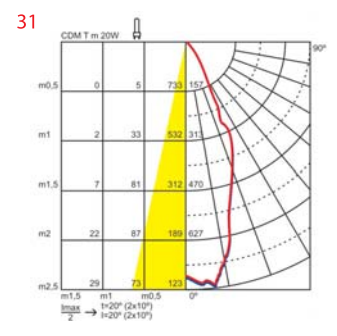
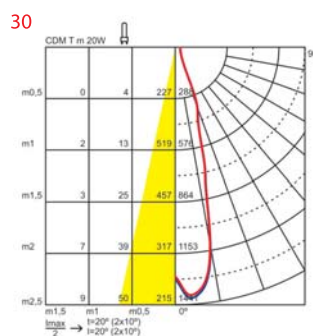
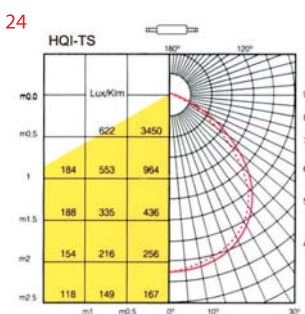
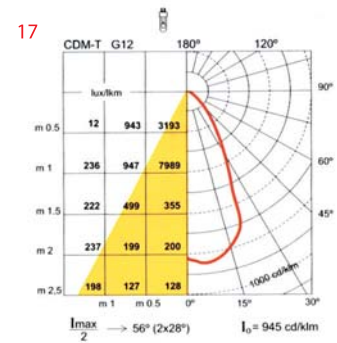
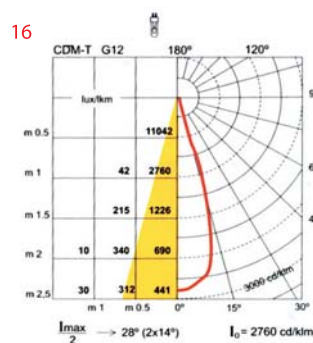
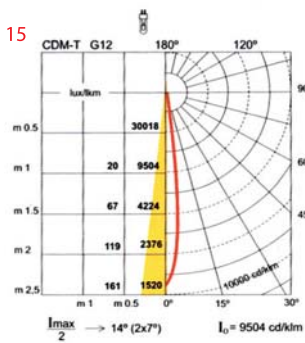





















fotometría



lâmpadas

lamps



















lámpadas

desenho	ref. ZVEI	tipo de lâmpada	base	potência (W)	tensão (V)	ref. OSRAM	ref. PHILIPS
incandescente							
	A60	Incandescente	E27	25,40,60,100	120/240	Classic	Standart
	R63	Incandescente Refletora	E27	40,60	120/240	Concentra Spot R63	Mini-Spot
halógenas							
	QT12	Halógena Bipino de Baixa Tensão	GY6,35	20,50	12	Halostar	Cápsula 12V
	QT14	Halógena Bipino em Tensão de Rede	G9	40,60	120/240	Halopin	Cápsula (Clickline)
	QPAR16	Halógena Refletora	GZ10	50	120/240	Halopar 16	Twistline
	QPAR20	Halógena Refletora	E27	50	120/240	Halopar 20	Par Pro 20
	QPAR30	Halógena Refletora	E27	75	120/240	Halopar 30	Par Pro 30
	QPAR38	Halógena Refletora	E27	100	120/240	Halopar 38	Par Pro 38
	QR48	Halógena com Refletor de Alumínio	GY4	20	12	Halospot 48	
	QR70	Halógena com Refletor de Alumínio	BA15d	50	12	Halospot 70	
	QR111	Halógena com Refletor de Alumínio	G53	35,50,65,100	12	Halospot 111	ALR Aluline Pro
	QR-CB51	Dicrónica Baixa Tensão	GU5,3	20,50	12	Decostar 51, Decostar Titan, Decostar Alum	Dicrónica Essential, Brilliantline Pro
	QR-CB35	Dicrónica Baixa Tensão	GU5,3	35	12	Decostar 35 S	Mini Dicrónica BrilliantLine
	QT-DE12	Halógena Bilateral	R7s	100,150	120/240	Haloline	Duplo Contato (Palito)
fluorescente compacta							
	TC-TSE	Fluorescente Compacta Eletrônica	E27	5,8,11,14,15,18,20	120/240	Dulux Energy Saver	Master Universal, Essential
	TC-TSE	Fluorescente Compacta Eletrônica	E27	15,20,23	120/240	Duluxstar Mini Twist	Twister
	TC-S	Fluorescente Compacta Simples 2P	G23	9,11,13		Dulux S	PL-S/2P Pro
	TC-S	Fluorescente Compacta Simples 2P	2G7	9,11		Dulux S/E	Master PL-S/4P
	TC-D	Fluorescente Compacta Dupla 2P	G24d-2	13,18,26		Dulux D	Master PL-C/2P
	TC-D	Fluorescente Compacta Dupla 2P	G24d-3	13,18,26		Dulux D	Master PL-C/2P
	TC-DEL	Fluorescente Compacta Dupla 4P	G24q-2	18,26		Dulux D/E	Master PL-C/4P
	TC-DEL	Fluorescente Compacta Dupla 4P	G24q-3	18,26		Dulux D/E	Master PL-C/4P
	TC-TEL	Fluorescente Compacta Tripla 4P	GX24q-3	18,26,32,42		Dulux T/E	Master PL-T/4P
	TC-TEL	Fluorescente Compacta Tripla 4P	GX24q-4	18,26,32,42		Dulux T/E	Master PL-T/4P
	TC-L	Fluorescente Compacta Longa	2G11	36,55		Dulux L	Master PL-L/4P

lâmpadas

lamps

lámpadas

desenho	ref. ZVEI	tipo de lâmpada	base	potência (W)	tensão (V)	ref. OSRAM	ref. PHILIPS
Fluorescente Tubular							
	T16	Fluorescente Tubular T5	G5	14,28,54		Lumilux T5 HE/HO	Master TL5
	T16	Fluorescente Tubular T5	G5	14,28,54		Lumilux T5 HE/HO	Master TL5
	T26	Fluorescente Tubular T8	G13	16,18,32,36,58		Fluro. Tubular Energy Saver (T8)	Master TLDRS, Master TLD, TLTRS Pro
	T26	Fluorescente Tubular T8	G13	16,18,32,36,58		Fluro. Tubular Energy Saver (T8)	Master TLDRS, Master TLD, TLTRS Pro
	T38	Fluorescente Tubular T12	G13	18,36,32		Fluorescente Tubular Comum	TLT/TLD Standard
Descarga Alta Pressão							
	HIT-CRI	Multivapores Metálicos Tubular c/ Base Bipino	G12	73		Powerstar, Powerball HCI T	Master Colour CDM-T
	HIT-CRI	Multivapores Metálicos Tubular c/ Base Bipino	PGJ5	20			Mini Master Colour CDM-Tm
	HI-PAR20	Multivapores Metálicos Refletora	E27	35		Powerstar HCI PAR 20	Master Colour CDM-R PAR 20
	HI-PAR30	Multivapores Metálicos Refletora	E27	35,70		Powerstar HCI PAR 30	Master Colour CDM-R PAR 30
	HI-PAR38	Multivapores Metálicos Refletora	E27	25		Powerstar HQI R	Master Colour CDM PAR 38 - integrada
	HI-R111	Multivapores Metálicos c/ Refletor em Alumínio	GX8,5	35,70		Powerstar HQI R111	Master Colour CDM-R 111
	HIT-DE	Multivapores Metálicos Bilateral	RX7s	70		Powerstar HQI TS, Powerball HCI TS	MHW-TD Pro, Master Colour CDM-TD
	HIT-DE	Multivapores Metálicos Bilateral	RX7s-24	150		Powerstar HQI TS, Powerball HCI TS	MHW-TD Pro, Master Colour CDM-TD
	HIT-DE	Multivapores Metálicos Bilateral	Fc2	250,400		Powerstar HQI TS, Powerball HCI TS	
	HIE	Multivapores Metálicos Elipsoidal	E27	70,100,150		Powerstar HQI E, Powerball HCI-E/P	Master HPI, Master Colour CDO-ET
	HIE	Multivapores Metálicos Elipsoidal	E40	70,100,150		Powerstar HQI E, Powerball HCI-E/P	Master HPI, Master Colour CDO-ET
	HIT	Multivapores Metálicos Tubular	E40	70,100,150		Powerstar HQI T	Master HPI-T, Master Colour CDO-TT
	HST	Vapor de Sódio Tubular	E27	70		SON-E, VIALOX NAV-T, SON-T	MASTER SON-T Plus, SON, SON-T
	HST	Vapor de Sódio Tubular	E40	100,150,250,400,600		VIALOX NAV-E, SON-E, VIALOX NAV-T, SON-T	MASTER SON-T Plus, SON, SON-T

Altena

Evoluindo com a luz

Av. Tranquillo Giannini, 920
Tel.: 11 4602 8666 / Fax: 11 4602 8665
Atendimento aos clientes: DG 0800 171 666
e-mail: vendas@altena.com.br www.altena.com.br